



Anschlageinrichtungen
DIN EN 795:2012
www.dekra-siegel.de



Fallnet® SR

- (D)** Einbau-, Gebrauchsanleitung und Kontrollkarte
- (Eng)** Installation and Instruction Manual and Inspection Chart
- (F)** Notice de montage, d'utilisation et carte de contrôle
- (I)** Istruzioni di montaggio, d'impiego e documento di controllo
- (E)** Instrucciones de montaje y de uso, y tarjeta de control

Leben auf dem Dach



Inhaltsübersicht/ List of Contents/ Sommaire/ Contenuto/ Índice

(D)		(Eng)		(F)	
Einbauanleitung	Seite 3	Installation Manual	Page 7	Notice de montage	Page 11
Gebrauchsanleitung	Seite 5	Instruction Manual	Page 9	Notice d'utilisation	Page 13
Herstellerangaben	Seite 6	Details on Manufacturer	Page 10	Indications du fabricant	Page 14
Kontrollkarte	Seite 31	Inspection Chart	Page 23	Carte de contrôle	Page 25
(I)		(E)			
Istruzioni di montaggio	Pagina 15	Instrucciones de montaje	Página 19		
Istruzioni d'impiego	Pagina 17	Instrucciones de uso	Página 22		
Indicazioni del produttore	Pagina 18	Especificaciones	Página 22		
Documento di controllo	Pagina 27	Tarjeta de control	Página 29		

Vorgehensweise/ Procedure/ Approche/ Modo di procedere/ Procedimiento



1. Einmessen des Anschlagpunktes

- 1. Measuring the position of the anchor point
- 1. Mesure de la position du point d'accrochage
- 1. Misurazione e posizionamento del punto di ancoraggio
- 1. Colocación a medida y posicionado del punto de anclaje

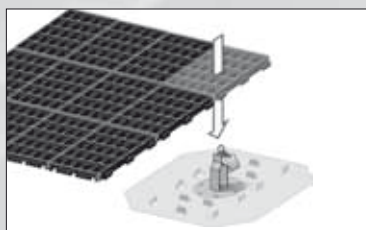

2. Markierte Rastergruppe mit dem Anschlagpunkt verbinden

- 2. Place the marked grid over the anchor point and click into place
- 2. Emboîter le groupe grillagé muni d'un marquage sur le point d'ancrage et le pousser vers le bas
- 2. Inserire il gruppo di griglie marcate sul punto d'ancoraggio e premere verso il basso
- 2. Colocar el elemento modular marcado encima del punto de anclaje y presionar hacia abajo hasta que se encaje en su lugar

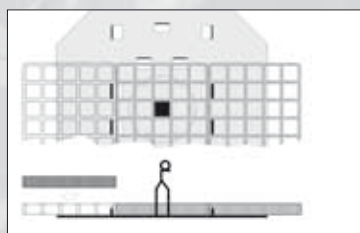

3. Die Raster müssen vollständig auf der Grundplatte aufliegen und die senkrechten Laschen die Nachelemente hintergreifen.

- 3. The grid must fully cover the base plate and the vertical locking tabs must engage the adjacent elements
- 3. Les grilles doivent sur toute leur surface sur la plaque de base et les languettes verticales s'encliqueter dans les grilles voisines.
- 3. Le griglie devono essere poggiate uniformemente sulla piastra di base e le linguette verticali devono incastrarsi negli elementi vicini.
- 3. Los elementos modulares deben asentarse por completo sobre la placa base y las pestañas verticales deben engancharse en los elementos contiguos.



4. Positionierung der Rastergruppe inklusive Anschlagpunkt

- 4. Positioning the grid and the Anchor Point
- 4. Positionnement du groupe de grilles, y compris le point d'accrochage
- 4. Posizionamento del gruppo di griglie incluso il punto di ancoraggio
- 4. Colocación de los elementos modulares y del punto de anclaje

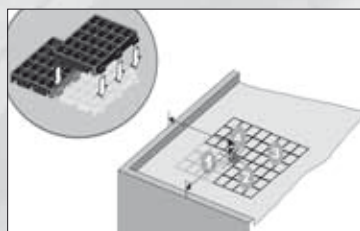

5. Verbinden der vier Rastergruppen und Prüfen der Positionierung

- 5. Connecting the four grids and check the position
- 5. Réalisation de la liaison entre les quatre groupes de grilles et contrôler le positionnement
- 5. Collegare i quattro gruppi di griglie e controllare il posizionamento
- 5. Conectar los cuatro elementos modulares y comprobar el posicionado



6. Aufbringen der erforderlichen Auflast (mind. 110 kg/m²)

- 6. Applying the required load (min. 110 kg/m²)
- 6. Mise en place de la charge nécessaire (110 kg/m² au min.)
- 6. Apporto della zavorra necessaria (al min. 110 kg/m²)
- 6. Colocación de la carga requerida (mínimo 110 kg/m²)

Important:

We would like to state explicitly that, regardless of product liability, ZinCo shall only assume liability for the consultancy process where installation has been carried out in line with ZinCo planning. Installation without planning carried out by ZinCo is at your own risk. Regardless of this, the installation manual and instruction manual must be observed. Please check the following prior to installing the anchor device Fallnet® SR:

0.1 Delivery scope / condition of the system components

Check: that the shipment is complete and in perfect condition.
Important: incomplete, faulty or incorrect shipments should be reported immediately.

The delivery scope per Fallnet® SR consists of:

- anchor point:

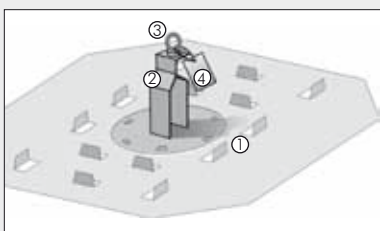

1. Base plate with vertical locking tabs
2. Support
3. Anchor eye
4. Identification label

- Load bearing element (2.00 x 2.67 m) consisting of four pre-assembled grids to hold the load.

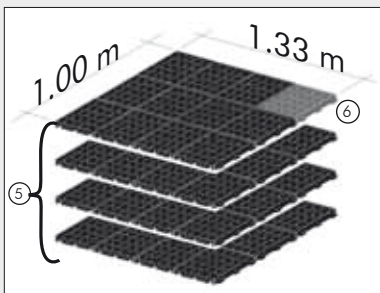

5. Four pre-assembled grids à 1.00 x 1.33 m
6. Marker and device for correctly positioning the single anchor point

0.2 Check the situation before installation

Prior to installation please check that the roof construction is sufficiently dimensioned for the required loads, waterproofing and if required root barriers are in place and the actual sub-base for the Fallnet® SR is properly and evenly laid and is not steeper than 5 degree (=8,8 %). If you are in any doubt, please clarify prior to installation. The surface must be free of dirt, oil and moss or lichen prior to installing Fallnet® SR. If necessary, sweep the surface.

0.3 General points

The Fallnet® SR can be installed, for example,

- On the protective layer above the waterproof layer (e.g. ZinCo protection mat SSM 45 with single-course green roof or ZinCo Filter Sheet TG with a gravel roof)
- Please ensure that there are no objects (e.g. concrete slabs) in the area of the Anchor Point (radius of at least 0.5 m)
- on the filter sheet (e.g. for multi-course green roof)
- Also ensure that the bulk material to be used as the load on the Fallnet® SR extends at least 50 cm beyond all four edges of the grid elements

Important:

The Fallnet® SR must always be in direct contact with the load (bulk material)! It must, therefore, be filled and covered completely with suitable bulk material (UV protection!).

Zincolit or ZinCo system earth, gravel or some other similar bulk material can be used. Must only be installed on roofs with a pitch of a maximum 5 degrees (= 8.8 %)!

The required load (dry weight) for Fallnet® SR is at least 110 kg/m². This is to be increased to 130 kg/m² if the roof pitch is greater than 2° (3.4 %) and it is possible to fall in the direction of the slope.

Where the Fallnet® SR is to be incorporated into a green roof, a min. 300 mm wide gravel strip should be left all around the Anchor Point, so that it is easier to see.

1.1 Measuring The Anchor Point

Measure out the position of the Anchor Point using a roof site plan. Please ensure that the anchor eye is positioned at a distance of at least 2.50 m from the roof edge.

1.2 Connect marked grid with Anchor Point

Place the punched opening in the middle of the coloured element of the pre-assembled grid (1.00 x 1.33) over the anchor point. Gently click into place using your foot, so that it fully covers the base plate and the vertical locking tabs on the base plate engage behind the outer bar of the adjacent, black grid.

1.3 Positioning the grid and Anchor Point

The grid and anchor point are positioned over the measured point (see 1.1).

1.4 Connecting all four grids to each other

Then, connect the other three grids in such a way that the Anchor Point is in the centre of the connected grid area. The four pre-assembled grids provide a base area of about 5.3 m² in total. The Fallnet® SR must be placed fully on a level surface, all connection points must be clicked into place. The connection points can be separated again using a hammer. Faulty elements must be replaced.

1.5 Applying the required load

The installed Fallnet® SR is now filled and covered with the load (e.g. ZinCo System Substrate or gravel), for requirements see item 0.3 General Points.

2. Adapting to building-specific features

With Fallnet® SR, the form (2.00 x 2.67 m) specified in the Standard can be adapted to suit the particular building situation, where necessary.

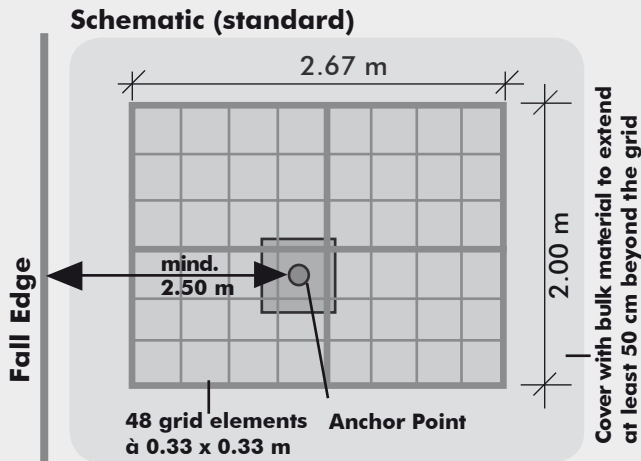

Schematic of a standard installation of the centred Anchor Point with the four pre-assembled grids (à 1.00 × 1.33 m).

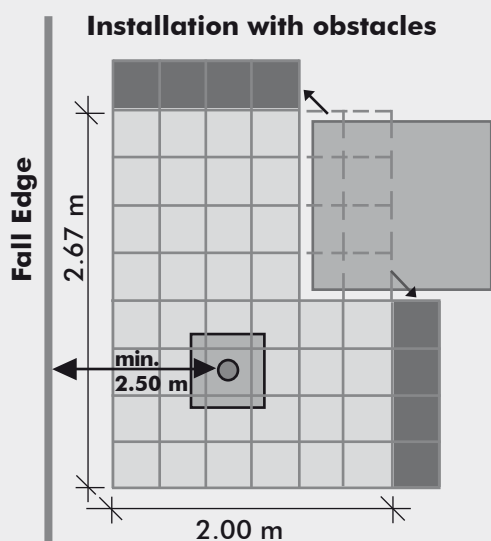

By moving the individual grid elements around, rising building elements or ventilation shafts, drains etc. can be embedded. Please note that the anchor point must not be positioned in either of the two outside grid rows. In addition, the Anchor Point must be placed in the centre of a grid element (0.33 × 0.33 m). In the stress direction, at least 20 grid elements must be behind the Anchor Point. We recommend having ZinCo plan and inspect such non-standard installation situations.

3.1 Completion, identification label

Please ensure that all works have been carried out satisfactorily and that the identification label can easily be seen and read. Only anchor devices that have an identification label may be used.

3.2 Installation documentation

The installation documentation is proof for the client that the installation has been carried out correctly and professionally. This documentation is also an essential basis for subsequent inspections of the Fallnet anchor device(s). A copy of the installation documentation is available in PDF from the manufacturer. On completion of installation, copies of the document are to be given to the client and are to be retained on the property for subsequent inspections of the Fallnet.

The following information is a minimum requirement for the installation documentation:

- address of property
- installation company
- technician responsible for installation
- fallnet serial numbers
- details of load (which bulk material, load weight, include delivery note, if relevant)
- installation plan (please include serial numbers here too)

The installation plan should be affixed to the building where it is clearly visible, e.g. at the roof access point.

Statement issued by the technician responsible for installation (signature):

- the Fallnet installation manual was adhered to
- installation was carried out as planned
- minimum load requirements have been adhered to
- photo documentation, in particular of details that are no longer visible after installation.

3.3 Handing over the Fallnet® SR documentation to the client/ owner

The delivery scope includes the following documents, which the installer must hand to the client:

- Installation Manual and Instruction Manual
- Inspection chart. Please record the serial number of the Fallnet® SR in the chart. This number can be found on the identification label attached to the product. Fallnet® SR must be inspected regularly.

In addition, the following must be given to the client:

- Installation documentation
- Site plan

3.4 Queries

Should you have any queries, or be unsure about the correct use/installation of the product or require further detailed information for your own specific building project, please contact ZinCo GmbH.

Your roof protects your building, the contents and any valuables in it. In order to have the benefit of a fully-functioning roof over a long period of time, your roof must be installed professionally and must be inspected at regular intervals during its lifetime and, where necessary, repair work carried out. Therefore, it is important to ensure that any works on the roof are carried out safely. The client (and later on possibly other) owners also have a duty here and are responsible for adherence to any regulations pertaining to occupational safety on a roof.

Used in combination with a load of suitable material (e.g. green roofing, substrate or gravel), Fallnet® SR provides an Anchor Point in accordance with EN 795:2012 Type E for fall prevention on flat roofs.

1. Fallnet® SR system components:

a. Anchor Point

Fully factory-assembled, consisting of anchor eye, approx. 175 mm high support and base plate in metal, size 0.75 x 0.75 m, with vertical locking tabs. The identification label (incl. serial number) is permanently attached to the anchor eye.

b. Load-bearing element, 2.00 x 2.67 m

Consists of four pre-assembled grids à 1.00 x 1.33 m. One of these elements has a label and a device for the standard positioning of the single anchor point. In total, 48 individual grid elements (0.33 x 0.33 m) with click connections around the edge. Height approx. 30 mm.

c. Documents

The delivery scope includes the following documents, which the installer must hand to the client:

- Installation Manual and Instruction Manual
- Inspection chart. Please record the serial number of the Fallnet® SR in the chart. This number can be found on the identification label attached to the product. Fallnet® SR must be inspected regularly.

In addition, the following must be given to the client:

- Installation documentation
- Installationplan

2. Scope and requirements for use

Fallnet® SR must only be used for the intended purpose as an Anchor Point for personal protection equipment. Fallnet® SR must not be used for lifting weights or for attaching objects. Any modification or addition to any of the system components requires the prior written permission of the manufacturer.

Please note also:

- Fallnet SR must only be used by 1 person at a time (max. 100 kg, including equipment).
- it must only be used for a roof pitch of maximum 5°
- it must only be installed on a suitable subsurface, i.e. either on a filter sheet (multi-course build-up) or on a protection mat or layer (single-course build-up), see Installation Manual).

Important: Direct contact with the load (bulk material) is required at all times.

The Fallnet® SR anchor eye must be installed at a distance of at least 2.50 m from the roof edge.

- the minimum fall distance to the ground (fall height) must be such as to prevent a person hitting the ground in the case of a fall event and to allow the person to swing freely. The required minimum fall distance to the ground (potential impact area) is calculated from the part distance of the connecting device, which is drawn over the roof edge (= largest possible rope length to the roof edge minus shortest rope length, at a right angle to the roof edge), the height of the person attached to the anchor point, the distance for the rope and safety harness stretch, rupture distance of fall absorber, the moving of the anchor device (max. 1,0 m)

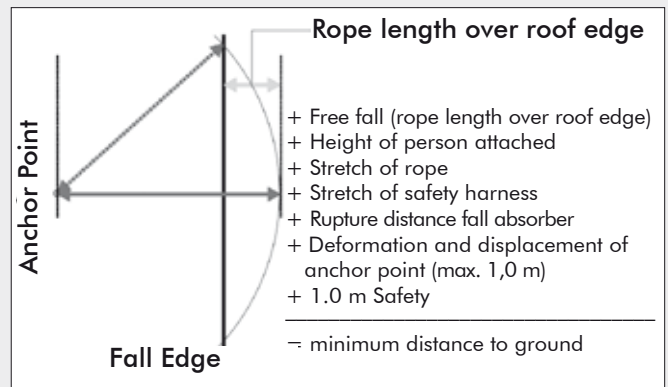

and an additional 1.0 m as safety value.

- In the case of a fall arrest event, the person may swing to and fro. It is important to ensure that there are no building elements in the way (e.g. balcony, awning etc.) and that

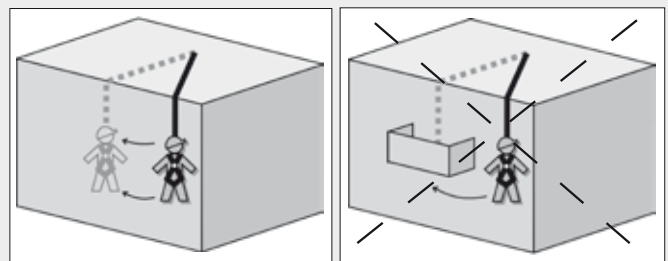

impact is prevented.

- to be used only with suitable personal protection equipment (PPE) for use on the horizontal. Such PPE in compliance with EN 363 (not part of the anchor point Fallnet® SR) must contain the following components:
 - Safety harness in compliance with EN 361
 - Fall absorber in compliance with EN 355 or safety appliance for use at height in compliance with EN 360 (Arresting forces each ≤ 6.0 kN)
 - Connecting device EN 354
 - Connection elements (carabiner) in compliance with EN 362

Please ensure that the individual system components are compatible and suitable for use on the horizontal and for a fall event over a roof edge. Potential danger resulting from a combination of the components used (in particular fall absorber, EN 355 or safety appliance for use at height, EN 360) should be eliminated. Therefore, prior to using personal protective equipment for fall arrest we recommend that you seek the advice of the manufacturer of the personal protective equipment. Please observe the manufacturer's Instruction Manual.

The following hazards may impact the proper functioning of the equipment: e.g. putting stress on the connection devices due to sharp edges, cuts, abrasion, slack rope, chemical, electric or climatic impact, extreme temperatures, swinging movement in the event of a fall. The connection devices, therefore, should always be inspected prior to use and if necessary, an edge protector must be provided.

The anchor device may be used in frosty conditions provided the device was installed in frost-free conditions.

3. Requirements for the use and for the user of Fallnet® SR

The anchor point Fallnet® SR must only be used by persons who have been instructed in the safe use of the equipment, who have the necessary knowledge and who, in terms of their health, are capable of using the equipment (e.g. no impairment due to medication, alcohol abuse, coronary or circulatory problems etc.).

The user is to be instructed such that s/he will carry out the following visual and manual inspections of the anchor point before each use:

- manual tensile loading and visual inspection of the visible stainless steel components, the support and the anchor eye
- visual inspection of the load height

Indications that the good working condition of the anchor point is restricted could be:

- the stainless steel parts (support and anchor eye) are deformed, weakened, soiled or are not in their original condition.
- the anchor point yields slightly when pulled
- there is an uneven level of material around the anchor point, e.g. as a result of drifting
- the black grids are visible.
- Objects (e.g. also concrete slabs) in the area of the anchor point (radius of at least 0.5 m) that would prevent the supports folding over as planned.

If there are concerns about the safe condition or the proper functioning of the anchor device, it must not be used and the builder/the owner must be notified.

Under no circumstances should the device be used until the situation has been clarified!

The individual anchor points are to be used in accordance with the plan for use. If there is no utilisation plan available, the length of the connection device of the PSA must always be adjusted such that a possible fall is prevented or a swinging fall does not result in impact. Prior to use, an emergency plan must be available in which all possible occupational emergency situations are addressed.

At the request of the client/owner, an inspection of the proper functioning of the entire safety equipment is to be carried out:

1. at least once a year
2. where required, e.g. if there is doubt about the proper functioning of the equipment (see "Indications of restricted functioning")
3. after 10 years a complete inspection of the system Fallnet® SR is to be carried out by the manufacturer.

The equipment must only be inspected by persons qualified to do so and details of all inspections must be recorded in the inspection chart.

It must also include the works listed under "Regular inspections" (page 23). The relevant check list is available in PDF from the manufacturer.

Attention:

After a fall arrest event, Fallnet® SR must be removed from service immediately. Further use of the equipment is not permitted. The product Fallnet® SR must only be used for the purpose and application as described. The manufacturer accepts liability for the product within the framework of applicable statutory requirements.

The manufacturer accepts no liability for any other deviating use of the product. Furthermore, the manufacturer accepts no liability where the Installation Manual and the Instruction Manual have been insufficiently adhered to. We wish to state explicitly that, regardless of product liability, ZinCo shall only assume liability for the consultancy process where installation has been carried out in line with ZinCo planning. Installation without planning carried out by ZinCo is at your own risk.

Where the anchor point Fallnet® SR is sold in another country, the technician / user must make available a copy of the Installation / Instruction Manual and the Inspection Chart in the language of that country.

4. Label

Manufacturer:	Zinco GmbH
Type:	Fallnet® SR
Standard:	EN 795:2012 Type E
Year manufactured:	date of manufacture (year)
Serial no.:	
Max. 1 person:	max. number of users



The notified body nominated for certification



Note that the Instruction Manual is to be observed



Fall protection equipment only to be used with a fall absorber

5. Details of manufacturer and testing institute

Manufacturer:
 ZinCo GmbH, Lise-Meitner-Strasse 2,
 72622 Nuertingen, Germany
 Phone: +49 (0) 7022 6003-0
 E-Mail: info@zinco-greenroof.com, www.zinco-greenroof.com

Testing institute:
 DEKRA EXAM GmbH,
 Dinnendahlstr. 9, 44809 Bochum, Germany
 Notified body N.B. 0158

Product identification card in compliance with EN 365	
Product	Fallnet® SR
Manufacturer	ZinCo GmbH, Lise-Meitner-Str. 2, 72622 Nuertingen, Germany
Building project	
Serial number(s)	
Purchase date	
Installation date	

Used in combination with a load consisting of suitable bulk material, Fallnet® SR is an anchor device in compliance with EN 795:2012 Typ E for fall protection on flat roofs. This device must only be used by a maximum of one person (up to 100 kg) at any one time and in combination with personal protection equipment (PPE) in compliance with EN 363. The safety harness in compliance with EN 361 must only be used together with tested and approved components.

Regular inspections

Inspections are required in order to ensure that the anchor device is functioning properly.

Such inspections must be carried out:

1. at least once a year
2. where required, e.g. if there is doubt about the proper functioning of the equipment (see "Indications of restricted functioning")

After 10 years a complete inspection of the system Fallnet® SR is to be carried out by the manufacturer.

The inspection works must be requested by the client/owner, are to be carried out by suitably qualified personnel who have been authorised by the manufacturer and are to be recorded on the rear side of this inspection chart.

The following inspection works are required:

- visual inspection for damage and the position of the anchor device,
- visual inspection to ensure that there are no objects in the area of the anchor point (radius of at least 0.5 m) that would prevent the supports folding over as planned,
- manual inspection with regard to tensile loading of the anchor point, and
- sufficient coverage/bulk material height (see Installation Manual),
- legibility of the product identification label.

Attention:

Under no circumstances should the anchor device be used if there is any doubt as to its perfect condition and safety for use. Please contact the client/owner immediately.

After 10 years, an overall inspection of the Fallnet® SR system is to be carried out by the manufacturer.



Inspection Chart Fallnet® SR

Overview of documentation and plan of inspection works.

Building:.....

.....

Inspection	Date	Address Authorised company/ person	Comments: reason for inspection, defects identified, repair work carried out	Date of next inspection	Signature
1st year					
2nd year					
3rd year					
4th year					
5th year					
6th year					
7th year					
8th year					
9th year					
10th year	Commission an overall inspection to be carried out by the manufacturer.				
Inspected serial number(s):					

Manufacturer:

ZinCo GmbH · Lise-Meitner-Strasse 2 · 72622 Nuertingen · Germany
 Tel. +49 (0) 7022 6003-0 · Email: info@zinco-greenroof.com
 www.zinco-greenroof.com

Testing institute:

DEKRA EXAM GmbH · Dinnendahlstr. 9 · 44809 Bochum, Germany
 Notified body N.B. 0158